

Industrialization and Urbanization

1800s

1. What was the population growth of the North, South, and West?
2. Which region grew the least?

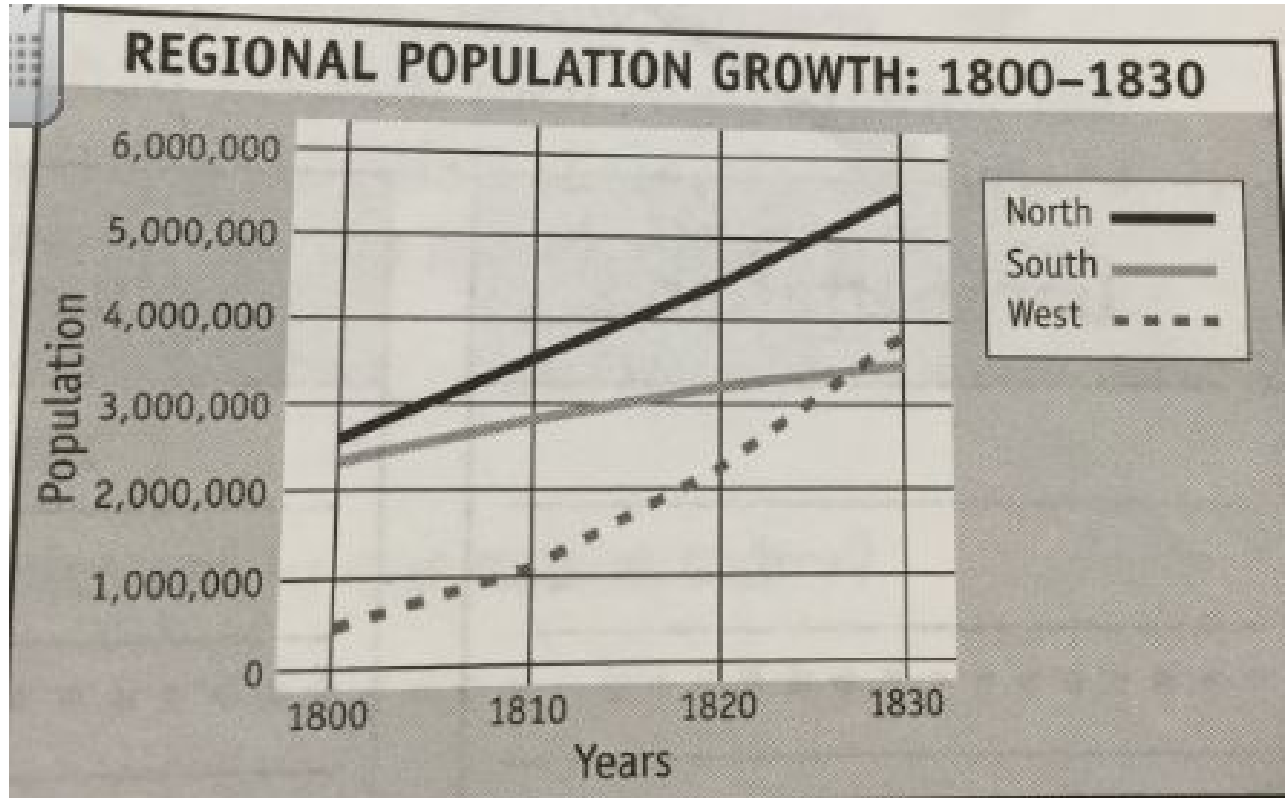

What factors do you think contributed to these trends?

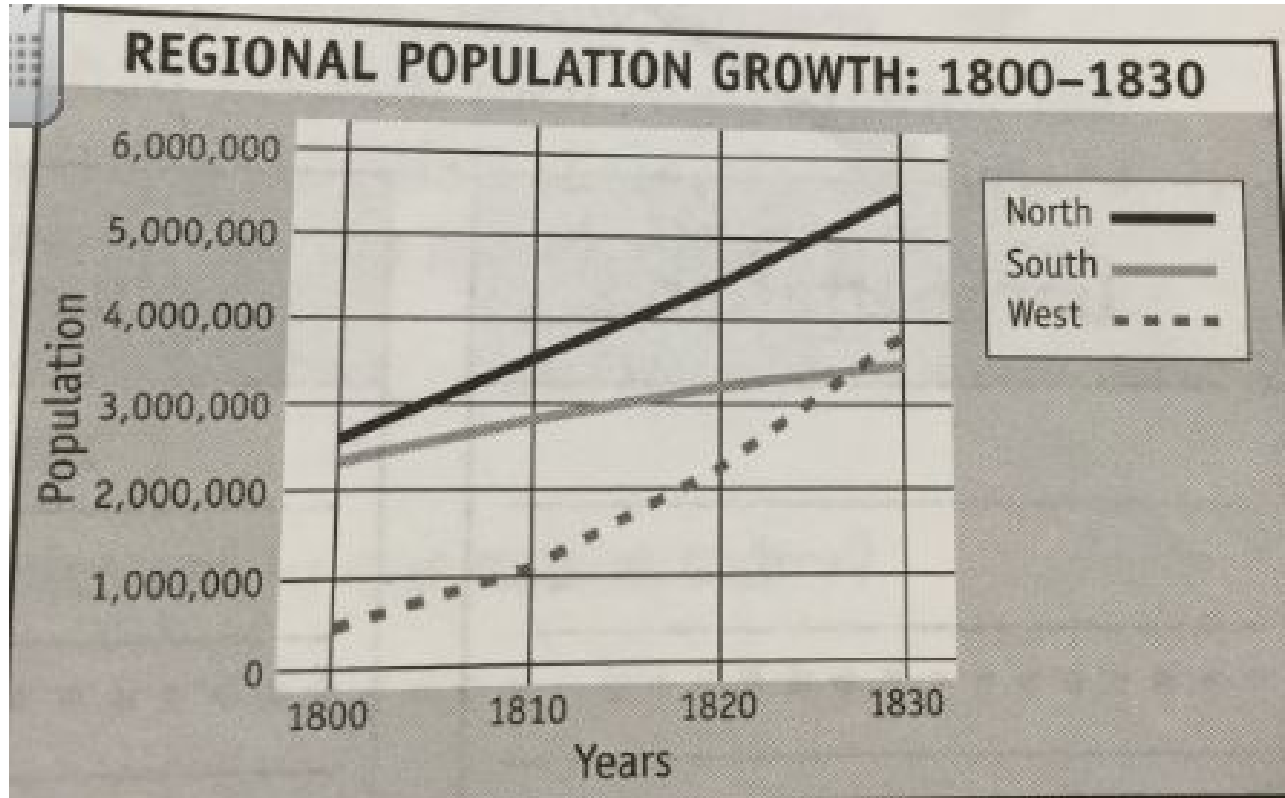

Before we read→ Here are important terms to know

The **Industrial Revolution** was the shift to factories due to an increase in technology and inventions

Urbanization- increased percentage of people move to cities and suburbs in order to make money in the factories

Essential Question

Why did factories and urbanization increase in America?

Read TEKS pg 176-177

Answer the corresponding questions on your handout

HIT LIST

Paragraph 1- What are the 3 basic economic questions?

Paragraph 2- Why do people invest money?

Paragraph 3- Why do consumers want choice?

Paragraph 4- Why did America have the freest economy in the world?

Inventions

Lowell System

THE LOWELL SYSTEM

- Hired only young unmarried women from local farms
- Worked 12-14 hour days



Cotton Gin



Interchangeable Parts

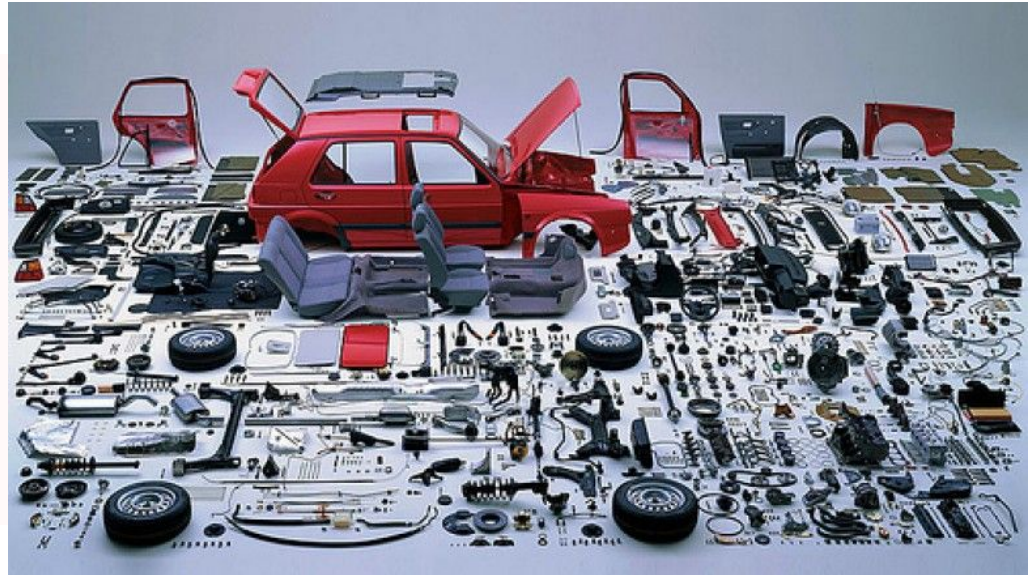
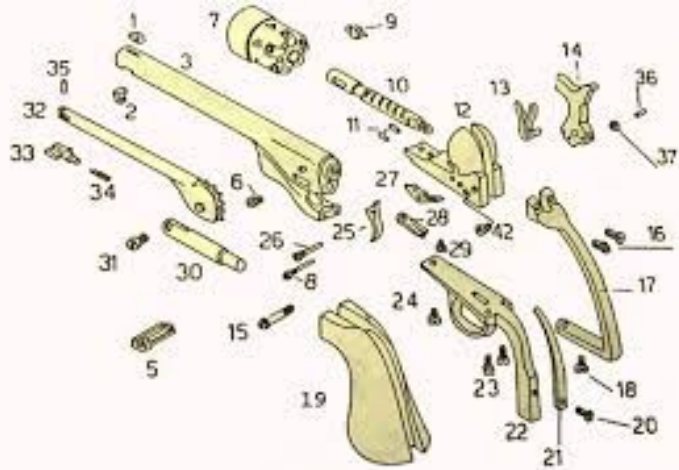

Railroads

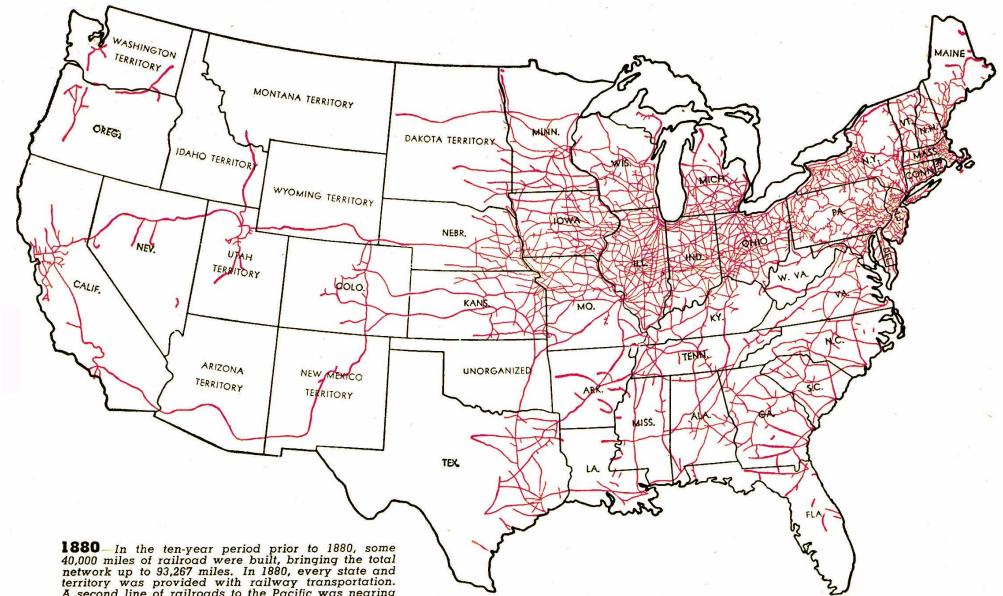

1880 In the ten-year period prior to 1880, some 40,000 miles of railroad were built, bringing the total network up to 35,267 miles. In 1880, every state and territory was provided with railway transportation. A second line of railroads to the Pacific was nearing completion, and other transcontinental railroads were under construction. Railway development was exerting a powerful influence upon immigration and agricultural and industrial growth throughout the country.

Steamboat/Steam Engine

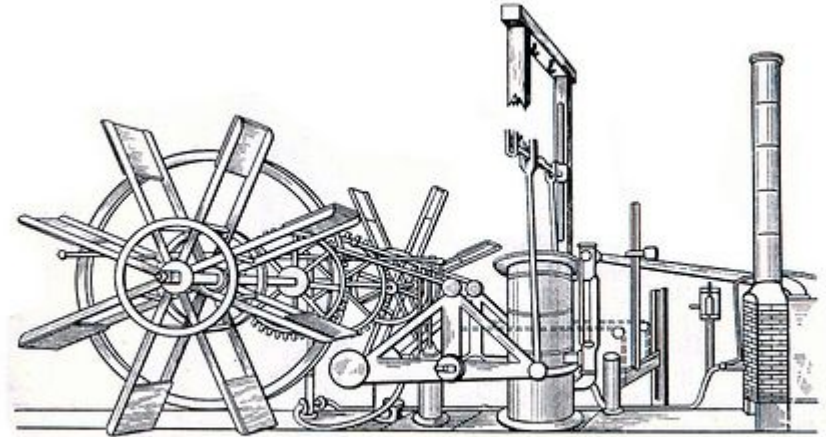
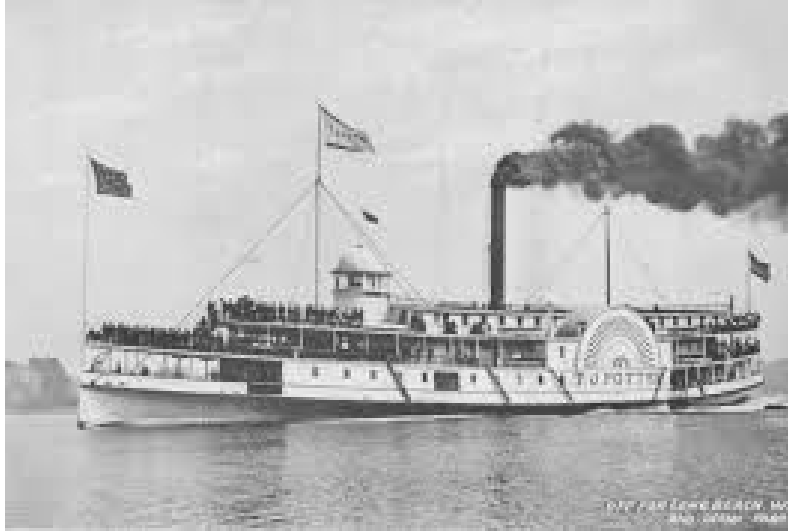

Erie Canal

